



CD4069UBM/CD4069UBC Inverter Circuits

General Description

The CD4069UB consists of six inverter circuits and is manufactured using complementary MOS (CMOS) to achieve wide power supply operating range, low power consumption, high noise immunity, and symmetric controlled rise and fall times.

This device is intended for all general purpose inverter applications where the special characteristics of the MM74C901, MM74C903, MM74C907, and CD4049A Hex Inverter/Buffers are not required. In those applications requiring larger noise immunity the MM74C14 or MM74C914 Hex Schmitt Trigger is suggested.

All inputs are protected from damage due to static discharge by diode clamps to V_{DD} and V_{SS} .

Features

- Wide supply voltage range 3.0V to 15V
- High noise immunity 0.45 V_{DD} typ.
- Low power TTL compatibility Fan out of 2 driving 74L or 1 driving 74LS
- Equivalent to MM54C04/MM74C04

Schematic and Connection Diagram

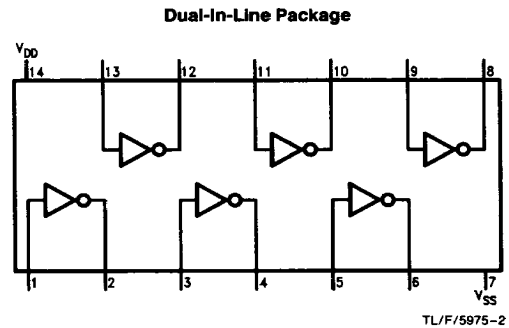
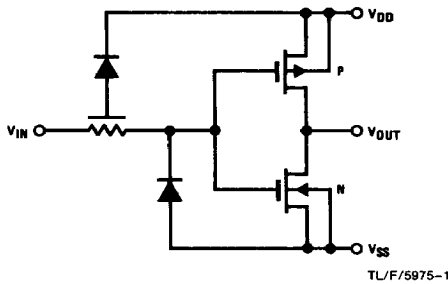

Order Number CD4069UB*

*Please look into Section 8, Appendix D for availability of various package types.

AC Test Circuits and Switching Time Waveforms

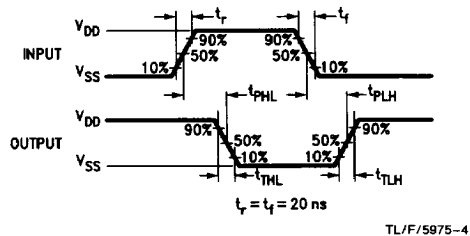
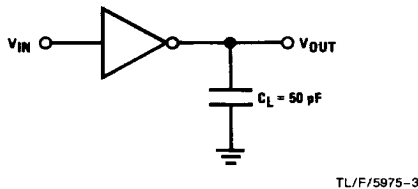

Absolute Maximum Ratings (Notes 1 & 2)

If Military/Aerospace specified devices are required, contact the National Semiconductor Sales Office/Distributors for availability and specifications.

DC Supply Voltage (V _{DD})	-0.5V to +18 V _{DC}
Input Voltage (V _{IN})	-0.5V to V _{DD} + 0.5 V _{DC}
Storage Temperature Range (T _S)	-85°C to +150°C
Power Dissipation (P _D)	
Dual-In-Line	700 mW
Small Outline	500 mW
Lead Temperature (T _L)	
(Soldering, 10 seconds)	260°C

Recommended Operating Conditions (Note 2)

DC Supply Voltage (V _{DD})	3V to 15V _{DC}
Input Voltage (V _{IN})	0V to V _{DD} V _{DC}
Operating Temperature Range (T _A)	
CD4069UBM	-55°C to +125°C
CD4069UBC	-40°C to +85°C

DC Electrical Characteristics CD4069UBM (Note 2)

Symbol	Parameter	Conditions	-55°C		+25°C			+125°C		Units
			Min	Max	Min	Typ	Max	Min	Max	
I _{DD}	Quiescent Device Current	V _{DD} = 5V, V _{IN} = V _{DD} or V _{SS}		0.25			0.25		7.5	μA
		V _{DD} = 10V, V _{IN} = V _{DD} or V _{SS}		0.5			0.5		15	μA
		V _{DD} = 15V, V _{IN} = V _{DD} or V _{SS}		1.0			1.0		30	μA
V _{OL}	Low Level Output Voltage	I _O < 1 μA V _{DD} = 5V		0.05		0	0.05		0.05	V
		V _{DD} = 10V		0.05		0	0.05		0.05	V
		V _{DD} = 15V		0.05		0	0.05		0.05	V
V _{OH}	High Level Output Voltage	I _O < 1 μA V _{DD} = 5V	4.95		4.95	5		4.95		V
		V _{DD} = 10V	9.95		9.95	10		9.95		V
		V _{DD} = 15V	14.95		14.95	15		14.95		V
V _{IL}	Low Level Input Voltage	I _O < 1 μA V _{DD} = 5V, V _O = 4.5V		1.0			1.0		1.0	V
		V _{DD} = 10V, V _O = 9V		2.0			2.0		2.0	V
		V _{DD} = 15V, V _O = 13.5V		3.0			3.0		3.0	V
V _{IH}	High Level Input Voltage	I _O < 1 μA V _{DD} = 5V, V _O = 0.5V	4.0		4.0			4.0		V
		V _{DD} = 10V, V _O = 1V	8.0		8.0			8.0		V
		V _{DD} = 15V, V _O = 1.5V	12.0		12.0			12.0		V
I _{OL}	Low Level Output Current (Note 3)	V _{DD} = 5V, V _O = 0.4V	0.64		0.51	0.88		0.36		mA
		V _{DD} = 10V, V _O = 0.5V	1.6		1.3	2.25		0.9		mA
		V _{DD} = 15V, V _O = 1.5V	4.2		3.4	8.8		2.4		mA
I _{OH}	High Level Output Current (Note 3)	V _{DD} = 5V, V _O = 4.6V	-0.64		-0.51	-0.88		-0.36		mA
		V _{DD} = 10V, V _O = 9.5V	-1.6		-1.3	-2.25		-0.9		mA
		V _{DD} = 15V, V _O = 13.5V	-4.2		-3.4	-8.8		-2.4		mA
I _{IN}	Input Current	V _{DD} = 15V, V _{IN} = 0V		-0.10		-10 ⁻⁵	-0.10		-1.0	μA
		V _{DD} = 15V, V _{IN} = 15V		0.10		10 ⁻⁵	0.10		1.0	μA

Note 1: "Absolute Maximum Ratings" are those values beyond which the safety of the device cannot be guaranteed. They are not meant to imply that the devices should be operated at these limits. The table of "Recommended Operating Conditions" and "Electrical Characteristics" provides conditions for actual device operation.

Note 2: V_{SS} = 0V unless otherwise specified.

Note 3: I_{OH} and I_{OL} are tested one output at a time.

DC Electrical Characteristics CD4069UBC (Note 2)

Symbol	Parameter	Conditions	-40°C		+25°C			+85°C		Units
			Min	Max	Min	Typ	Max	Min	Max	
I _{DD}	Quiescent Device Current	V _{DD} = 5V, V _{IN} = V _{DD} or V _{SS}		1.0			1.0		7.5	μA
		V _{DD} = 10V, V _{IN} = V _{DD} or V _{SS}		2.0		2.0		15	μA	
		V _{DD} = 15V, V _{IN} = V _{DD} or V _{SS}		4.0		4.0		30	μA	
V _{OL}	Low Level Output Voltage	I _O < 1 μA V _{DD} = 5V		0.05		0	0.05		0.05	V
		V _{DD} = 10V		0.05		0	0.05		0.05	V
		V _{DD} = 15V		0.05		0	0.05		0.05	V
V _{OH}	High Level Output Voltage	I _O < 1 μA V _{DD} = 5V	4.95		4.95			4.95		V
		V _{DD} = 10V	9.95		9.95			9.95		V
		V _{DD} = 15V	14.95		14.95			14.95		V
V _{IL}	Low Level Input Voltage	I _O < 1 μA V _{DD} = 5V, V _O = 4.5V		1.0			1.0		1.0	V
		V _{DD} = 10V, V _O = 9V		2.0			2.0		2.0	V
		V _{DD} = 15V, V _O = 13.5V		3.0			3.0		3.0	V
V _{IH}	High Level Input Voltage	I _O < 1 μA V _{DD} = 5V, V _O = 0.5V	4.0		4.0			4.0		V
		V _{DD} = 10V, V _O = 1V	8.0		8.0			8.0		V
		V _{DD} = 15V, V _O = 1.5V	12.0		12.0			12.0		V
I _{OL}	Low Level Output Current (Note 3)	V _{DD} = 5V, V _O = 0.4V	0.52		0.44	0.88		0.36		mA
		V _{DD} = 10V, V _O = 0.5V	1.3		1.1	2.25		0.9		mA
		V _{DD} = 15V, V _O = 1.5V	3.6		3.0	8.8		2.4		mA
I _{OH}	High Level Output Current (Note 3)	V _{DD} = 5V, V _O = 4.6V	-0.52		-0.44	-0.88		-0.36		mA
		V _{DD} = 10V, V _O = 9.5V	-1.3		-1.1	-2.25		-0.9		mA
		V _{DD} = 15V, V _O = 13.5V	-3.6		-3.0	-8.8		-2.4		mA
I _{IN}	Input Current	V _{DD} = 15V, V _{IN} = 0V		-0.30		-10 ⁻⁵	-0.30		-1.0	μA
		V _{DD} = 15V, V _{IN} = 15V		0.30		10 ⁻⁵	0.30		1.0	μA

AC Electrical Characteristics*

T_A = 25°C, C_L = 50 pF, R_L = 200 kΩ, t_r and t_f ≤ 20 ns, unless otherwise specified

Symbol	Parameter	Conditions	Min	Typ	Max	Units
t _{PHL} or t _{PLH}	Propagation Delay Time from Input to Output	V _{DD} = 5V		50	90	ns
		V _{DD} = 10V		30	60	ns
		V _{DD} = 15V		25	50	ns
t _{THL} or t _{TLH}	Transition Time	V _{DD} = 5V		80	150	ns
		V _{DD} = 10V		50	100	ns
		V _{DD} = 15V		40	80	ns
C _{IN}	Average Input Capacitance	Any Gate		6	15	pF
C _{PD}	Power Dissipation Capacitance	Any Gate (Note 4)		12		pF

*AC Parameters are guaranteed by DC correlated testing.

Note 1: "Absolute Maximum Ratings" are those values beyond which the safety of the device cannot be guaranteed. They are not meant to imply that the devices should be operated at these limits. The table of "Recommended Operating Conditions" and "Electrical Characteristics" provides conditions for actual device operation.

Note 2: V_{SS} = 0V unless otherwise specified.

Note 3: I_{OH} and I_{OL} are tested one output at a time.

Note 4: C_{PD} determines the no load AC power consumption of any CMOS device. For complete explanation, see 54C/74C Family Characteristics application note—AN-90.

Typical Performance Characteristics

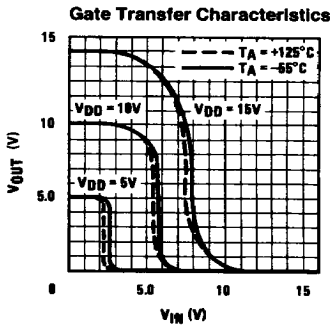

TL/F/5975-5

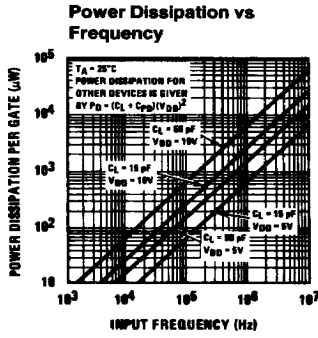

TL/F/5975-6

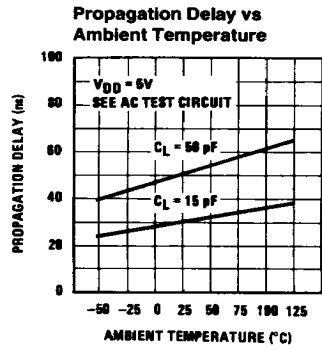

TL/F/5975-7

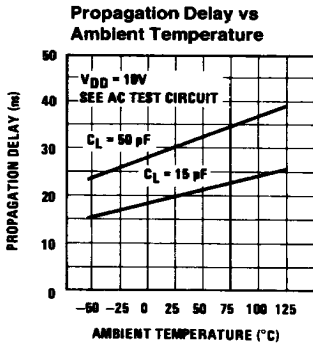

TL/F/5975-8

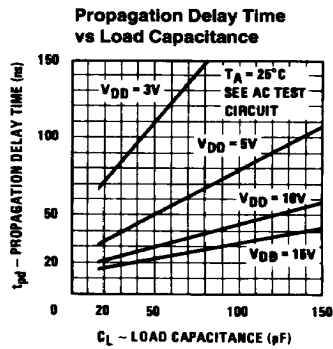

TL/F/5975-9